



DL300A

Engine Power : SAE J1995, gross 156 kW(212 HP)@ 2,100 rpm

Operational Weight : 17,640 kg - STD.

Bucket capacity(SAE) : 2.7 ~ 3.3 m³(3.3 ~ 4.3 cu.yd)



Doosan Infracore Korea Office
27/F, Doosan Tower 18-12, Euljiro-6Ga, Jung-Gu
Seoul 100-730 Korea
Tel : 82 2 3398 8114

Doosan Infracore Europe S.A.
Add 1A, Rue Achille Degrace Frameries B7080 Belgium
Tel : 32 478295266

Doosan Infracore U.K.
Unit 6.3- Nantgarw Park Treforest Ind. Estate Cardiff
CF157QU U.K.
Tel : 44 1443 845650

Doosan Infracore Europe S.A. Germany
Heinrich von stephan Strasse 2 Langenfeld-Fuhrkamp
DE-40764 Germany
Tel : 49 2173 2035218

Doosan Infracore France
ZAC de la Clef Saint Pierre - Buroplus 2 1a,
avenue Jean d' Alembert Elancourt F78990 France
Tel : 33 1 3016 2151

Doosan Infracore America Corporation
2905 Shawnee Industrial Way, Suwanee, Georgia 30024, U. S. A
Tel : 770 831 2236

Doosan Infracore China Co., Ltd.
No.28 Wuzhishan Road, Eco&Tech. Development Area,
Yantai Shandong 264006 China
Tel : 135 0535 2797

Doosan Infracore Russia
123610, MOSCOW / Russia Fed., Kransnopresnenskaya quay 12,
Office No. 1503
Tel: 7 495 258 1837

Doosan Infracore Middle East Center (Dubai)
P.O. Box 262688, Jebel Ali, Dubai - UAE
Tel : 971 4 8864660, 8855828

Doosan Infracore South América Indústria e Comércio de Máquinas de Construção Ltda.
Alameda Santos, 787 - Conjunto 91, Cerqueira César
CEP : 01419-001, São Paulo/SP, Brazil
Tel : 55 11 2505 6150

Doosan Infracore India Pvt.Ltd
3rd Floor, TNPL Building No.67, Mount Road,
Guindy Chennai 600032 India
Tel : 91 99 4064 8687



www.doosaninfracore.com/ce/ae/en



Photo may include optional equipment

Wheel loader : DOOSAN DL300A

A Powerful Wheel loader with Novel Features



DL300A

The new DL300A wheel loader has all the advantages of the previous loaders. This logical new step provides real added value to the operator.

The new DL300A was developed with the concept of "providing optimum value to the end user." In concrete terms, this translates, into :



Increased production due to the use of powerful DEo8TIS engine and the excellent synchronisation of the drive train with the hydraulics system.

Improved ergonomics, increased comfort and excellent all round visibility ensuring safe and pleasant working conditions.

Improved reliability through the use of higher performance new materials, the development of new computer-assisted structural design techniques and by intensive and systematic test programs. All of these combine to increase the life of vital components and reduce operating costs.

Reduced maintenance increases the availability of the loader and reduces operating costs.

PERFORMANCE

DL300A

The DL300A is a machine that delivers a powerful, highly effective force, offering superior penetration of the hardest materials. The exceptional drawbar pull at the wheels, is reinforced further by providing limited-slip differentials as standard equipment. The engine offers high power and torque characteristics. As a result, the hydraulic system is able to multi-function with power and speed.

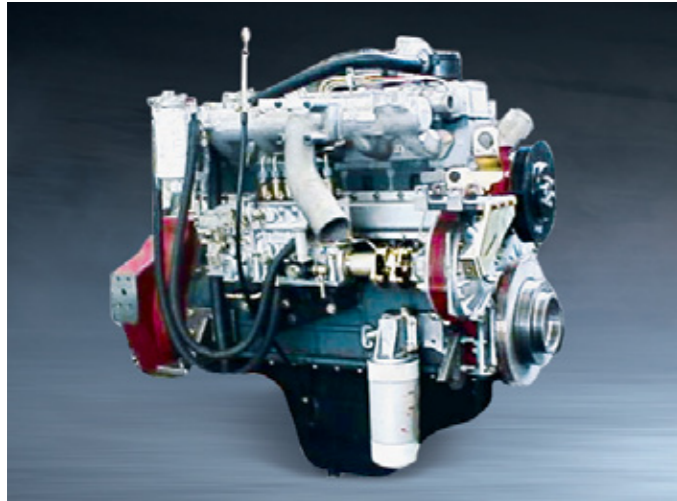

DOOSAN "DEo8TIS" Engine

Our many years of experience in engine design and production have resulted in the emergence of a highly efficient and very powerful engine that boasts the highest power in its class.



Full Auto Transmission

The electronic powershift transmission is particularly smooth and gear ratios perfectly spaced to give optimal speed. That gives comfort at the same time that it delivers excellent traction in every working conditions. Built-in electronic controls enhance productivity and durability.

Axle

Improved internal oil flow greatly reduced the temperature difference between the hub and the differential, as well as prevents premature disc wear due to overheating of the internal hub components.



LSD (Limited Slip Differential)

The standard equipment LSD allows easy driving through soft and swampy grounds.

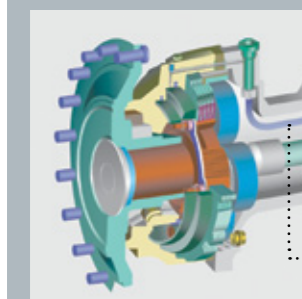

Increased Axle Durability

The brake discs have been repositioned to the rear part of the reduction gear where the rotation speed is lower. As a result, the discs are exposed to lower rpm's and heat generation is reduced and the life span of the discs is greatly extended. Automatic disc clearance regulator has been intergrated into the design and the disc clearance is maintained at the optimum level at all times as the discs wear out. This prevents any lag in brake response. Another convenient feature is that brake disc wear can easily be measured without disassembling the hub.

The brake piping has been redesigned into the axle housing and is protected from damage from external shock as the machine drives over rough terrain.

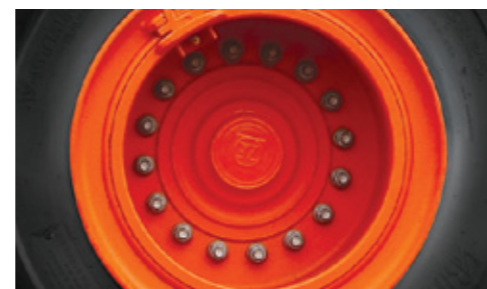
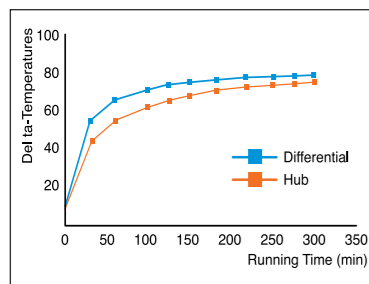

• This result may change according to test condition.



Hydraulic Power Steering

The newly designed steering system ensures smooth steering even in the low engine speed ranges. - Steering control valve



High Lift

As High Lift is equipped besides Standard Lift, customers have further options.

COMFORT

From the beginning, Doosan has had great concern for machine operators. People need to work in a well-designed and comfortable environment. The work area is spacious, with several places for storage. The checking and monitoring devices are comprehensive. There is an open view of the work area. For night work, operators are provided with powerful front and rear lighting.



DL300A



Air Conditioning & Defroster System

Double filtered air cab, air ducts are properly placed all around the cab with proportional sensitive controls and air re-circulation facility. we offer the same comfort as a passenger car.



Air-Suspension Seat (Option)

Now available Air-suspension seats provide more comfort and support for the operator.



The Steering Column

The steering column features both tilting and telescopic functions.

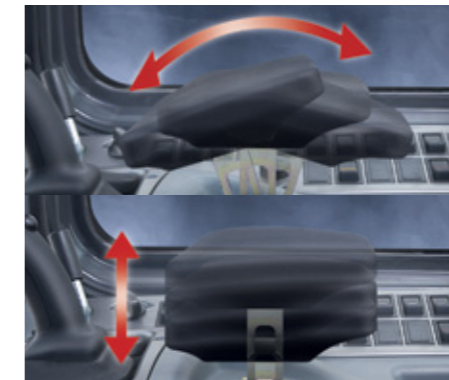

Wrist Rest

The tilting and telescopic wrist rest allows the operator to work more comfortably.



Various Control Lever

The joystick installed in compliance with various needs and preferences of operators ensures more convenient work.



Switch

The ergonomically laid out switch panel in line with the natural movements of the body allows for very convenient operation. The spare switch cut-outs allows easy installation of additional electric accessories.



Central Monitor Panel

The compact central monitor panel is ergonomically designed and allows the operator to monitor the status and warning lights at a single glance.



Sunvisor & Room Mirror(Std.)

MAINTENANCE

DL300A

A liquid crystal display conveys information to the operator relative to the ZF transmission. At the same time, it reports the nature of a problem (if one exists). When servicing the loader, a specialised apparatus can be used to adjust the clutch disks to compensate for their wear. Additionally, by connecting a laptop computer, a complete transmission diagnostic can be performed.

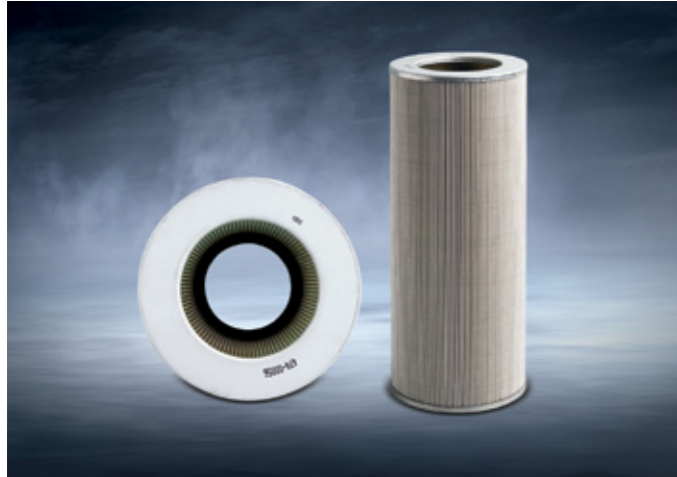

Hydraulic Oil Return Filter
The high-efficiency, large-capacity return filter manufactured with the glass-fiber media can eliminate foreign substances up to 99.5 percent to protect the costly hydraulic equipment and substantially extend the replacement cycle.



Central Joints
A good accessibility at the articulation joint is essential for an easy maintenance.



Air-Cleaner Filter
The high capacity air cleaner eliminates harmful particles from the air and extends the life of the engine and replacement intervals.

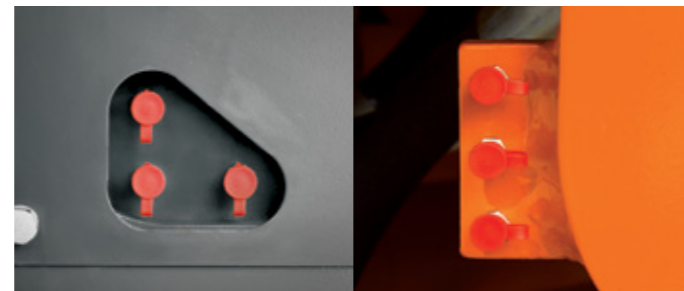

Greasing Lubrication Ports
The front pins can be lubricated from the outside of the machine without crawling under the machine or in awkward positions through the lubrication ports.



Remote Engine oil & Coolant Drain
Remote drain valves have been installed in an easily accessible location for convenient draining of fluids. (Coolant - upper, Engine oil - lower)



Large Capacity Transmission Oil Cooler
The large capacity transmission oil cooler ensures durable and stable operation of transmission.



Transmission Filter
The transmission filters are within easy reach and like the rest of the machine's service components, can be checked from ground level.

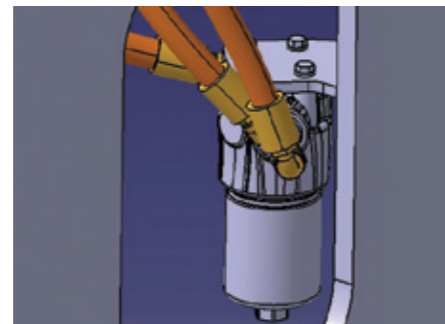

Brake & Pilot Filter
The pilot filter is easy to replace and protect hydraulic system.

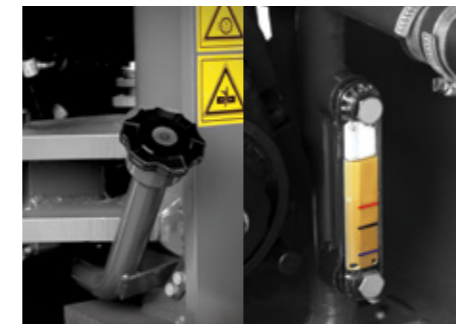

Convenient Transmission Oil Filling
Because the transmission oil level gauge is attached to the oil filler pipe, it is easy to visually check the level while filling. In addition, the oil filler pipe is located near the articulation joint for easy access.

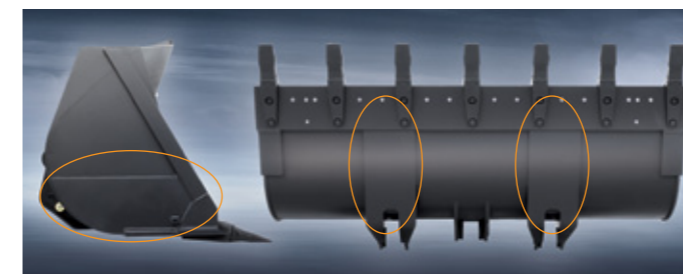

Reinforced Bucket
The lower and side panels of the bucket have been reinforced with additional plates (Std).
- Reinforcement : At both sides - 1 point each
At lower panel - 2 point



Hydraulically Operated Fan
Hydraulically operated fan can swing out and is very easy to clean the cooler cores. Air conditioning condenser is combined with radiator assembly and can be tilt for easier cleaning.

Sight Gauges
Well-located, yet easily visible sight gauges for the hydraulic oil and radiator coolant allow easy daily checks while reducing the risk of contaminants entering the systems.

RELIABILITY

DL300A

Every morning, when the operators commence work, they know that things will go smoothly- because Doosan has taken care of it. The product is soild. Operators know that they have significant reserves at hand and that they won't have to push the machine to its limit. The Doosan DL300A wheel loader is designed and built to last. For Doosan, 'reliable' means availability, accessibility and simplicity.

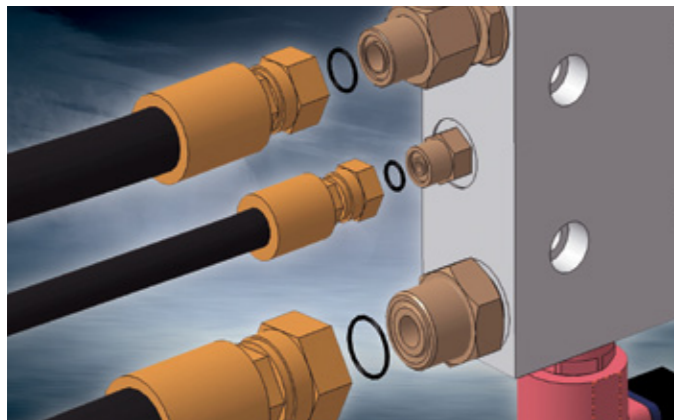

ORFS-All Ports (Even in Pilot line and Low pressure line)



2-Piece Type Tooth (Pin-on+Bolt-on adapter)

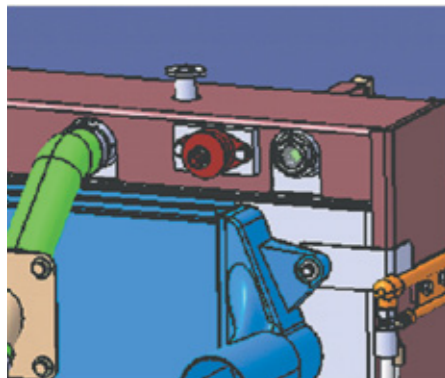

Rubber-Mounting (for Radiator: Lateral 2EA / Vertical 2EA)



Propeller Shaft
A protective cover has been installed to protect the oil seal from dust, foreign objects and premature wear.



Radiator Grill (Steel structure)

STANDARD AND OPTIONAL EQUIPMENT

*STANDARD EQUIPMENT

• Engine

- Three stage air cleaner with cyclone pre-cleaner, inner filter, And external plugging indicator as at the dashboard
- Maintenance warning lamp
- Hydraulically driven fan
- External drains for engine oil and coolant

• Lifting and Hydraulic system

- Robust Z bar lifting system
- Standard general purposes 3.0 m³ bucket
- Single lever joystick
- Hydraulic control valve with two sections
- Automatic boom kick out
- Automatic bucket return to dig.
- Fast couplers for hydraulic check
- Fixed tandem vane pump system

• Steering system

- Load sensing steering system

• External equipments

- Mudguard
- Lower protection plates
- Lifting hooks
- Articulation lock in the transport position
- Towing hitch
- Tools compartment

• Electric System

- Alternator 60A / 24 V
- Working lights: 2 at the front and 4 at the rear (6 x 70W)
- Driving lights: low and high beams
- Tail indicators, stop, reversing lights
- Reversing alarm

• Loader Linkage

- Z-bar loader linkage

• Drive line and Brake system

- Gear box which can be declutched when braking
- Gear box with diagnosis and monitoring indicator, and electronic plug for a fast adjustment
- Selection of Manual or Automatic mode
- Starting safety system
- Kickdown and travelling direction selection: lever at left of the steering wheel or on the joystick
- Limited slip differential on front and rear axles
- Dual brake circuits with accumulator
- Tire 23.5 - 25 - 16PR (L3)
- Dual service brake pedals
- Secondary brake system
- Parking brake on the transmission, electric-hydraulic

• Cab

- Air-conditioning / heating with recirculation function
- Double Filtered air cab
- Mechanical suspension seat with safety belt(2")
- Adjustable steering column
- Compartment for cans
- Floor mat
- Tinted glasses
- Left sliding window
- Front and rear wiper
- Front and rear washers
- Sun visor
- Interior cab light
- Interior rear view mirrors (2)
- Exterior rear view mirrors (2)
- Machine monitoring (condition, control & maintenance indicators in front of the driver by dials, gauges and lamps)
- Main switches in front of the driver (Starter & hazard switches)
- Switches for the general functions in the right console
- Electrical horn
- Cigarette lighter
- MP3 / CD player
- 12 Volt socket
- Cup holder
- Compartment for Shoes
- Glass antenna
- Side Mirror (STD)
Heatwire in side mirror (optional)
- ROPS Cabin(Rollover Protective Structure): ROPS Meets The Following Criteria
- SAE 1040 , ISO 3471
- FOPS Cabin(Falling Objects Protective Structure): FOPS Meets The Following Criteria - SAE J 231, ISO 3449
- Digital clock
- Coat hook

* OPTIONAL EQUIPMENT

Some of these optional equipments may be standard in some markets. Some of these optional equipments cannot be available on some markets. You must check with the local Doosan dealer to know about the availability or to release the adaptation following the needs of the application.

• Ground Engaging Tools

- Various types of buckets, Pallet fork, timber grapples and accessories

• Tires

- L3, L5 following various types of manufacturers

• Hydraulic

- Hydraulic control valve with 3 sections
- FNR mono lever with 3rd function lever for third section
- Two hydraulic levers for 2 sections with FNR function
- Three hydraulic levers for 3 sections with FNR function
- Load isolation system (LIS)
- Emergency steering pump driven by electric motor

• Electric system

- Rotating beacon
- Additional lighting

• Cab

- Rear Camera (CCTV) and monitor
- Air suspension seat with 3" belt

• Various

- Full covering mudguard
- Tool Kit
- Mudguard

• External equipments

- Full fender with rubber protector
- Wheel chocks

• Loader Linkage

- Z-bar high lift loader linkage

• Bucket and Attachments

- Bolt-on teeth (BOT)
2.7m³ (3.5 cu.yd.)
3.0m³ (3.9 cu.yd.)
3.3m³ (4.3 cu.yd.)
- Bolt-on cutting edge (BOC)
2.9m³ (3.8 cu.yd.)
3.2m³ (4.2 cu.yd.)
- Bolt-on teeth & segments
3.2m³ (4.2 cu.yd.)

TECHNICAL SPECIFICATIONS

DL300A

* ENGINE

The high performance Doosan DE08TIS 6 cylinder, direct injection, turbo charged, air-air intercooler engine offers low fuel consumption and low exhaust emissions, which are well below the requirements of the Phase II legislation

-GROSS SAE J1995

• Rated Power :

156 kW @ 2,100rpm
209 HP @ 2,100rpm
212 ps @ 2,100rpm

• Max. Power :

209 HP @ 2,100 rpm

• Max Torque :

92 kgf.m @ 1,300rpm
902 Nm @ 1,300rpm

• Displacement :

8,070cc (492cu.in)

• Bore x stroke :

∅ 111x139mm(4.4"x 5.5")mm

3 stages Air cleaner including a very efficient pre-cleaner, main and safety elements.

Hydraulically driven puller type fan with possibility of adjustment.

• Battery :

System voltage : 24V
Quantity : 12Vx2
Capacity(AMP) : 150Ah

• Starter power :

6.6kW

• Alternator output :

60A

* AXLES

The front and rear axles with planetary hub reductions are built on the base of very reputed components.

Fitted as standard, the front and rear limited slip differentials, ensure the traction is optimal in all circumstances.

• Maker and model :

ZF MT-L3000 Series

• LSD Differential

30%

• Oscillation angle :

+/- 12°

• Brake :

Dual circuit multi-plate wet discs.
Hydraulic actuation with pump and accumulator.

The sintered metal brake discs extended discs service intervals : increased three times

A spring applied and hydraulically released parking brake is mounted on the transmission shaft.

* TRANSMISSION

"Full Power Shift" transmission. It can be used in manual or automatic modes.

This transmission is based on components having excellent worldwide reputations. It is equipped with a modulation system allowing soft gear shifting and inversion of travel direction. Safety devices also protect the transmission of bad operations.

The gear and direction shifting is operated by a single lever to the left of the steering wheel. A travel direction control is also mounted on the hydraulic joystick. (Opt.)

With a special electronic device, the transmission can be tested and adjusted easily for optimum performance and efficiently.

The transmission can be de-clutched by the operation of brake pedal to increase the power available to the hydraulic pumps.

A safety device prevents the starting of the engine when not in neutral.

• Torque converter :

Type : Single stage, one phase,
Stall ratio : 3.06

• Gear box :

Maker and model
ZF 4 WG 210

• Speed Forward/Rearward :

(Tire 23.5 - 25 - 16PR - L3)

1	6.0 / 6.3 km/h (3.7 / 3.9 mph)
2	11.6 / 12.2 km/h (7.2 / 7.6 mph)
3	21.4 / 22.3 km/h (13.3 / 13.9 mph)
4	32.3 km/h (20.1 mph)

* HYDRAULIC SYSTEM

The hydraulic system uses tandem vane pumps with automatic wear compensation.

Pilot actuation with standard single lever.

Automatic boom kick out and bucket return to dig. is standard.

All of hydraulic lines are equipped with special seals (ORFS)

• Max flow main:

(With steering)
130 ℓ / min (34.3g / min)
(Without steering)
280 ℓ / min (74g / min)

• Working Pressure:

200 bars

• Pressure of the pilot circuit:

30 bars

• Filtration capacity on the return line:

10 microns

• Loading cycles time:

Lifting speed (loaded) :
6 seconds
Dumping speed (loaded) :
1.8 seconds
Lowering speed (empty) :
3.3 seconds

* OPERATOR' CAB

The modular cab allows excellent visibility in all directions. The optimal ventilation is obtained by numerous ventilation outlets. Touch buttons control the air re-circulation air conditioning and heating systems. The air of the cab is filtered.

All necessary information for the operator are centralized in front of him.

The main functions are actuated via switches located on a console at the right of the operator.

Generous storage places are well located. The cab, mounted on viscous element and equipped with an air suspended seat, offers a better comfort for the operator.

• Access door:

1

• Emergency exits:

2

The cab conforms ROPS ISO 3471 and FOPS : ISO 3449

• Guaranteed external noise level Lwa:

(following 2000 / 14 / EC) 103 dB (A)

* STEERING

The steering system is a load sensing type with a flow amplifier and a priority valve.

• Steering angle :

40°

• Oil flow :

145 ℓ/min(38.3g / min) @ 2,300 rpm, high

• Working pressure :

185 bars

• Steering cylinders (2) :

bore x stroke : 80 x 450 mm (3.2" x 1' 6")

Emergency steering system with hydraulic pump driven by electric motor. (Opt.)

* LIFTING SYSTEM

The lifting system with two cylinders and Z configuration is designed for the toughest jobs. The breakout force (18 ton with a 3.0m³ bucket) is very important and the bucket movements are fast.

The bucket angles are well kept in good positions on all the range of bucket movement.

• Lifting cylinders (2)

bore x stroke : 150 x 831 mm (5.9" x 2'9")

• Bucket cylinders (1)

bore x stroke : 200 x 505 mm (7.7" x 1'8")

* MAINTENANCE

Maintenance is easy due to excellent access.

The radiator fan swivels to aid cleaning.

The transmission is electronically controlled. An error coding system allows easy diagnosis of the systems and proper intervention.

• Engine (oil) : 21 ℓ (5.5 gal)

• Radiator (cooling liquid) : 50 ℓ (13.2 gal)

• Fuel : 330 ℓ (87.2 gal) - ST

• Hydraulic oil : 210 ℓ (55.5 gal) - ST

• Gear box and torque converter : 48 ℓ (12.7 gal)

• Front axle : 42 ℓ (11.1 gal)

• Rear axle: 42 ℓ (11.1 gal)

OPERATIONAL DATA

Bucket type			General purpose							High Lift
Configuration	Code	Unit	Teeth	Teeth	Teeth (std.)	Teeth	Bolt-on edge	Bolt-on edge	Teeth & segments	Bolt-on edge
Capacity heaped ISO/SAE		m ³	2.7	3.0	3.0	3.3	2.9	3.2	3.2	3.2
Tooth type			Adapter tooth	-	Mono tooth	Mono tooth	-	-	Adapter tooth	-
Bucket width	A	mm	2,920	2,920	2,920	2,920	2,920	2,920	2,920	2,920
Breakout force		kN	176	168	168	168	176	167	167	161
Static tipping load (straight)		kg	13,650	13,350	13,670	13,390	13,520	13,225	13,190	10,930
Static tipping load (at full turn)		kg	11,860	11,600	11,880	11,635	11,750	11,495	11,465	9,500
Dump height (at 45°) ¹⁾ (at fully raised)	J	mm	2,800	2,730	2,779	2,779	2,918	2,849	2,730	3,401
Dump reach (at 45°) ¹⁾ (at fully raised)	I	mm	1,296	1,294	1,291	1,291	1,165	1,163	1,294	1,193
Digging depth	H	mm	78	118	78	78	78	118	118	243
Height at bucket pivot point	K	mm	3,980	3,980	3,980	3,980	3,980	3,980	3,980	4,531
Max. tilt angle at carry position	α	degree	48	48	48	48	48	48	48	51
Max. tilt angle at fully raised	β	degree	58	58	58	58	58	58	58	55
Max. tilt angle on ground		degree	45	45	45	45	45	45	45	45
External radius at tire side	R	mm	5,800	5,800	5,800	5,800	5,800	5,800	5,800	5,800
External radius at bucket edge	D	mm	6,421	6,453	6,427	6,427	6,376	6,407	6,453	6,646
Wheel base	G	mm	3,200	3,200	3,200	3,200	3,200	3,200	3,200	3,200
Width at tires	B	mm	2,760	2,760	2,760	2,760	2,760	2,760	2,760	2,760
Tread	V	mm	2,150	2,150	2,150	2,150	2,150	2,150	2,150	2,150
Ground clearance	C	mm	460	460	460	460	460	460	460	460
Overall length	F	mm	8,192	8,275	8,238	8,238	8,015	8,100	8,275	8,613
Overall height	E	mm	3,435	3,435	3,435	3,435	3,435	3,435	3,435	3,435
Operating weight		kg	17,855	17,910	17,640	17,870	17,980	18,030	18,065	18,155

- 1) Measured to the tip of the bucket teeth or bolt-on edge.
2) All measurements with tires 23.5-25-16PR(L3).

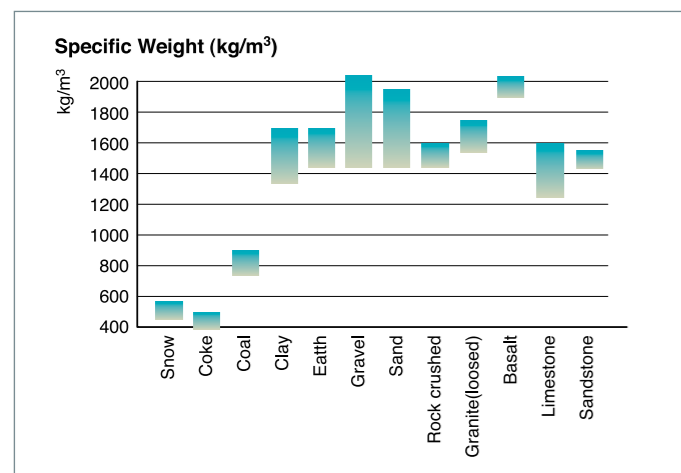

The specific weight of material largely depends on moisture rate, compacting value, percentage of various components etc... This chart is given only for information.

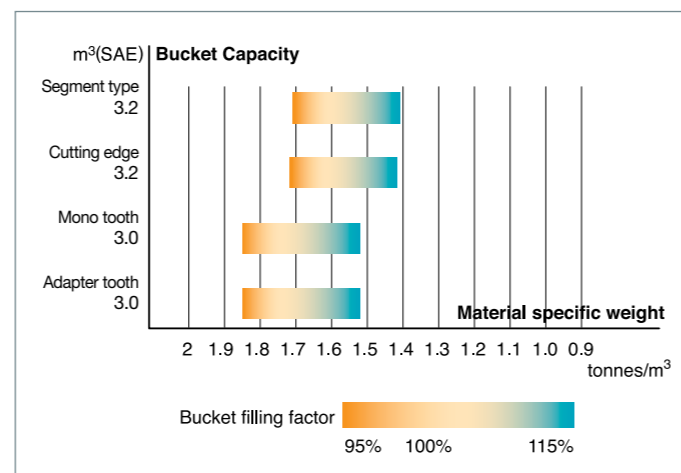

The Bucket filling factor depends also of the nature of material, the working conditions and the operator ability.

DIMENSIONS

DL300A

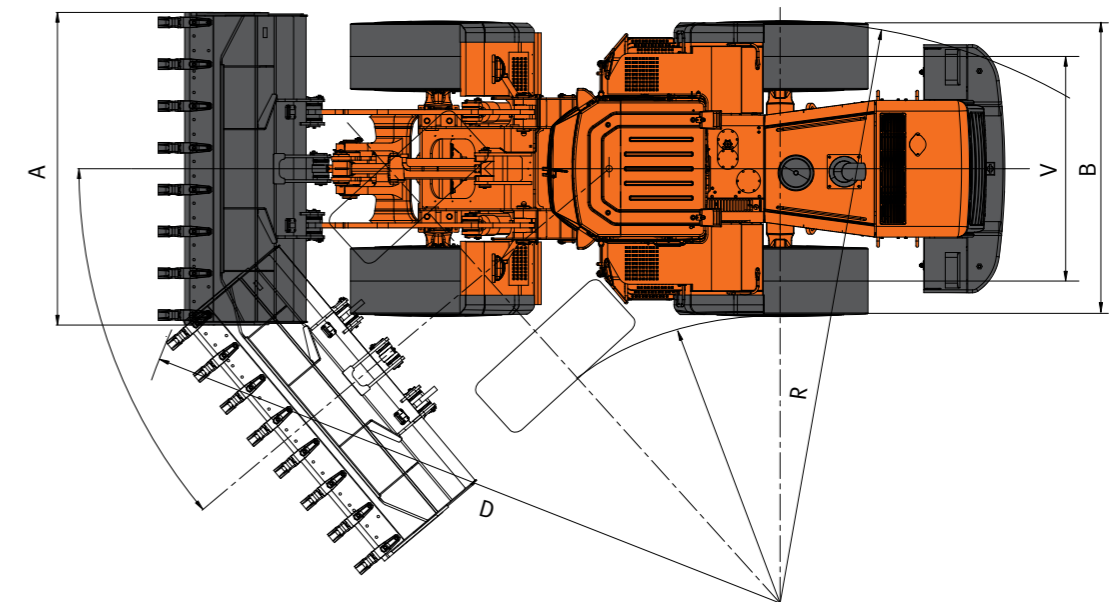
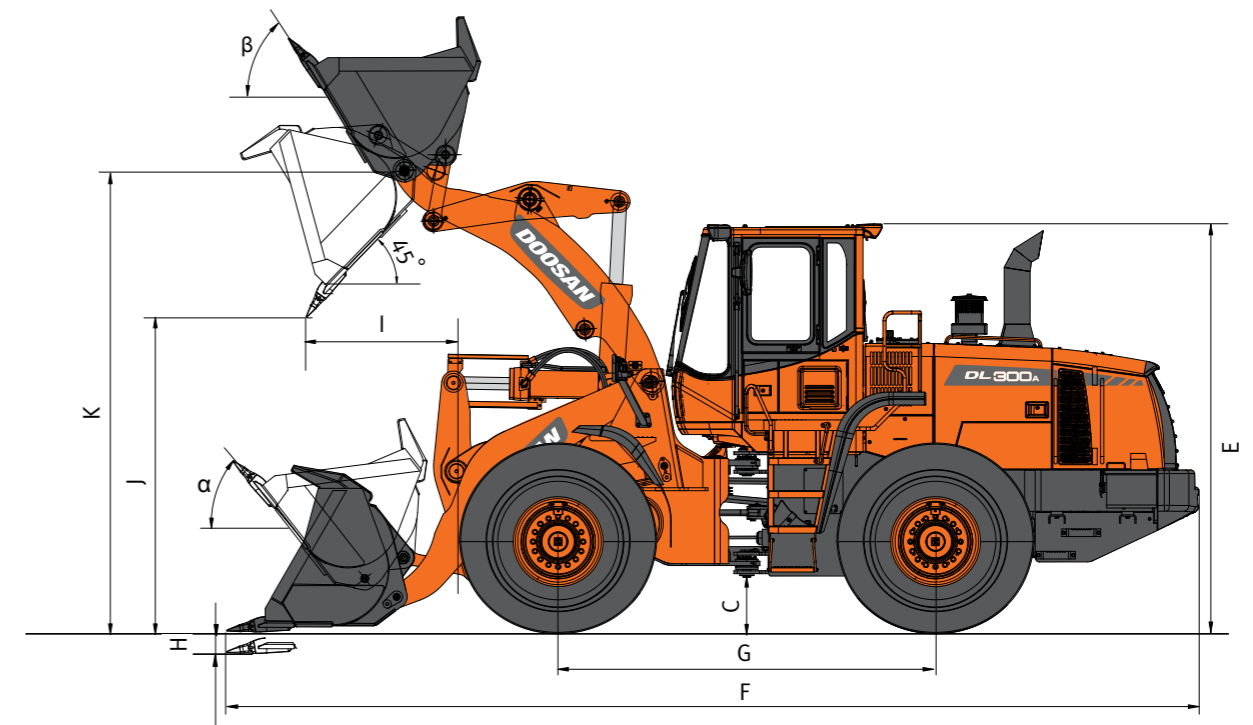

Measured to the tip of the bucket teeth or bolt on edge with tires 23.5-25-16PR(L3)